



PARKING & TRAFFIC
CONSULTANTS

Driving success through valuable advice

Proposed Rezoning, Erskine Park

For Penrith City Council

Traffic and Parking Assessment

23 November 2015

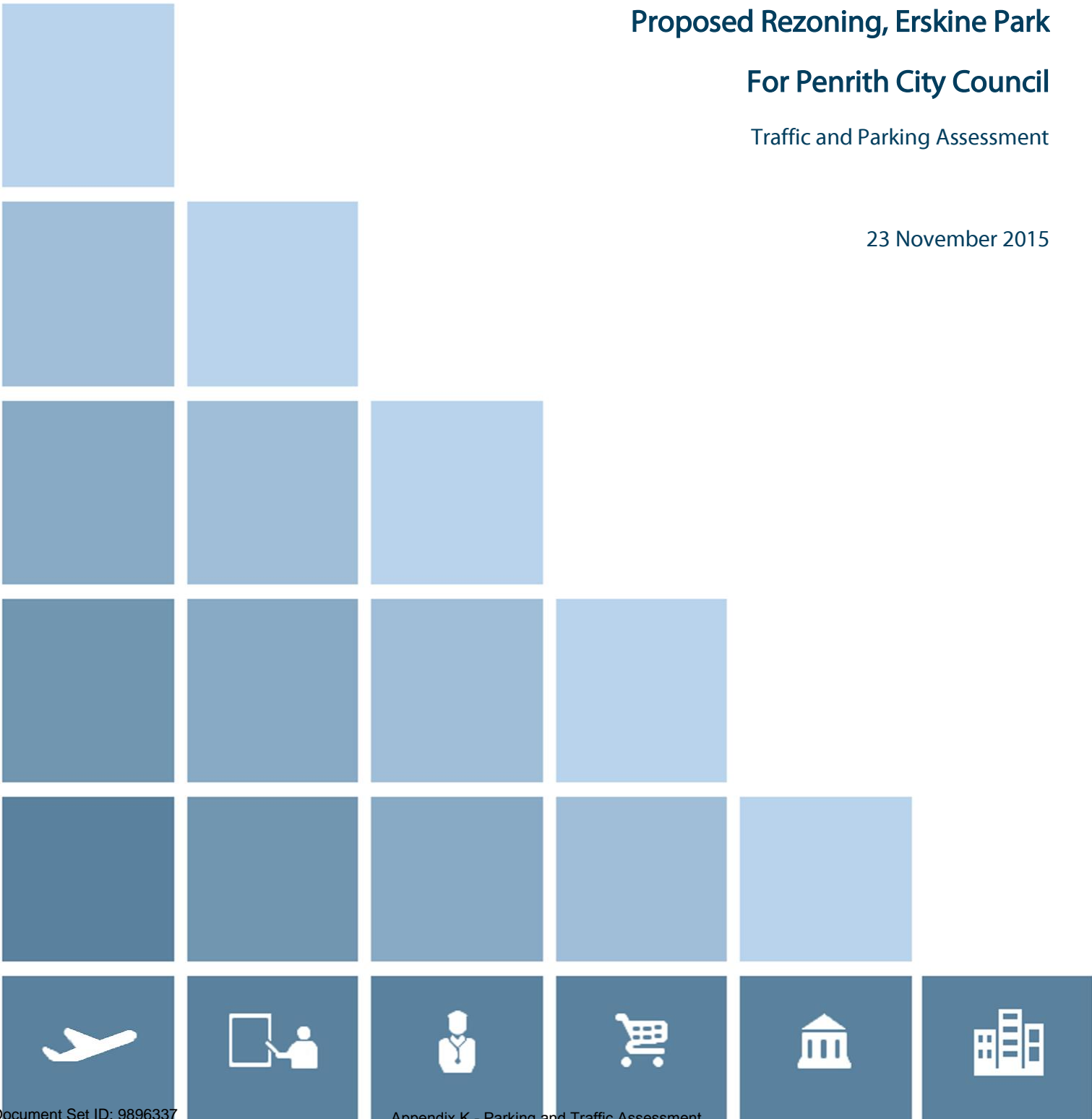

Document Control

Our Reference: T2-1524, Proposed Rezoning, Erskine Park, Traffic and Parking Assessment

ISSUE	DATE	ISSUE DETAILS	AUTHOR	REVIEWED
1	10 Nov 15	Draft for Client Review	MYee	AMorse
2	20 Nov 15	Final Issue	MYee	AMorse
3	23 Nov 15	Final Issue	MYee	AMorse

Contact

Monica Yee
02-89200800
0411490813
Monica.yee@parkingconsultants.com

COMMERCIAL IN CONFIDENCE

The information contained in this document, including any intellectual property rights arising from designs developed and documents created, is confidential and proprietary to Parking & Traffic Consultants (PTC).

This document may only be used by the person/organisation to whom it is addressed for the stated purpose for which it is provided and must not be imparted to or reproduced, in whole or in part, by any third person without the prior written approval of a PTC authorised representative. PTC reserves all legal rights and remedies in relation to any infringement of its rights in respect of its intellectual property and/or confidential information.

© 2015

PARKING & TRAFFIC CONSULTANTS
Suite 102, 506 Miller Street
Camberay NSW 2062

Ph. +61 2 8920 0800
Fax +61 2 8076 8665

Suite 406, 838 Collins Street
Docklands VIC 3008

Ph. +61 3 9020 7333

Contents

1	Introduction	1
1.1	Project Overview.....	1
1.2	Purpose of this Report.....	1
2	The Proposal.....	3
3	Existing Transport Facilities.....	7
4	Development Traffic Assessment	11
4.1	Traffic Generation.....	11
5	Car Parking Provision	14
5.1	Planning Policy Requirements.....	14
5.2	Car Parking Requirements.....	14
6	Access Assessment	15
6.1	Vehicular Access.....	15
6.2	Sight Distances.....	16
7	Conclusion.....	26
	Figure 1 – Location of rezoning lots.....	1
	Figure 2 – Road Hierarchy (Source: RMS Road Hierarchy Review)	7
	Figure 3 –Distribution of Traffic on Erskine Park Road	12
	Table 1 – Summary details of subdivision proposals (source: Penrith City Council, Oct 2015)	3
	Table 2 – Existing Road Network - Western Motorway (M4).....	7
	Table 3 – Existing Road Network – Erskine Park Road	8
	Table 4 – Existing Road Network – Explorers Way	8
	Table 5 – Existing Road Network – Spoonbill Street	8
	Table 6 – Existing Road Network – Swallow Drive	8
	Table 7 – Existing Road Network – Dilga Crescent	9
	Table 8 – Existing Road Network – Kawana Place.....	9
	Table 9 – Existing Road Network – Phoenix Crescent.....	9
	Table 10 – Existing Road Network – Chameleon Drive	10
	Table 11 – Existing Road Network – Ashwick Circuit	10
	Table 12 – Existing Road Network – Fuller Place.....	10
	Table 13 – Traffic Generation	11
	Table 14 – Parking Requirements	14

1 Introduction

1.1 Project Overview

Parking and Traffic Consultants (PTC) has been engaged by Penrith City Council, to prepare an assessment of the parking and traffic considerations associated with a proposed reclassification and reclassify rezoning of eight (8) separate sites within the suburbs of Erskine Park and St Clair.

Each of the sites is currently public reserve to be rezoned as residential and is expected to yield 26 lots classified as low residential housing dwellings, of which three (3) of these lots have the potential to accommodate a dual occupancy dwelling.

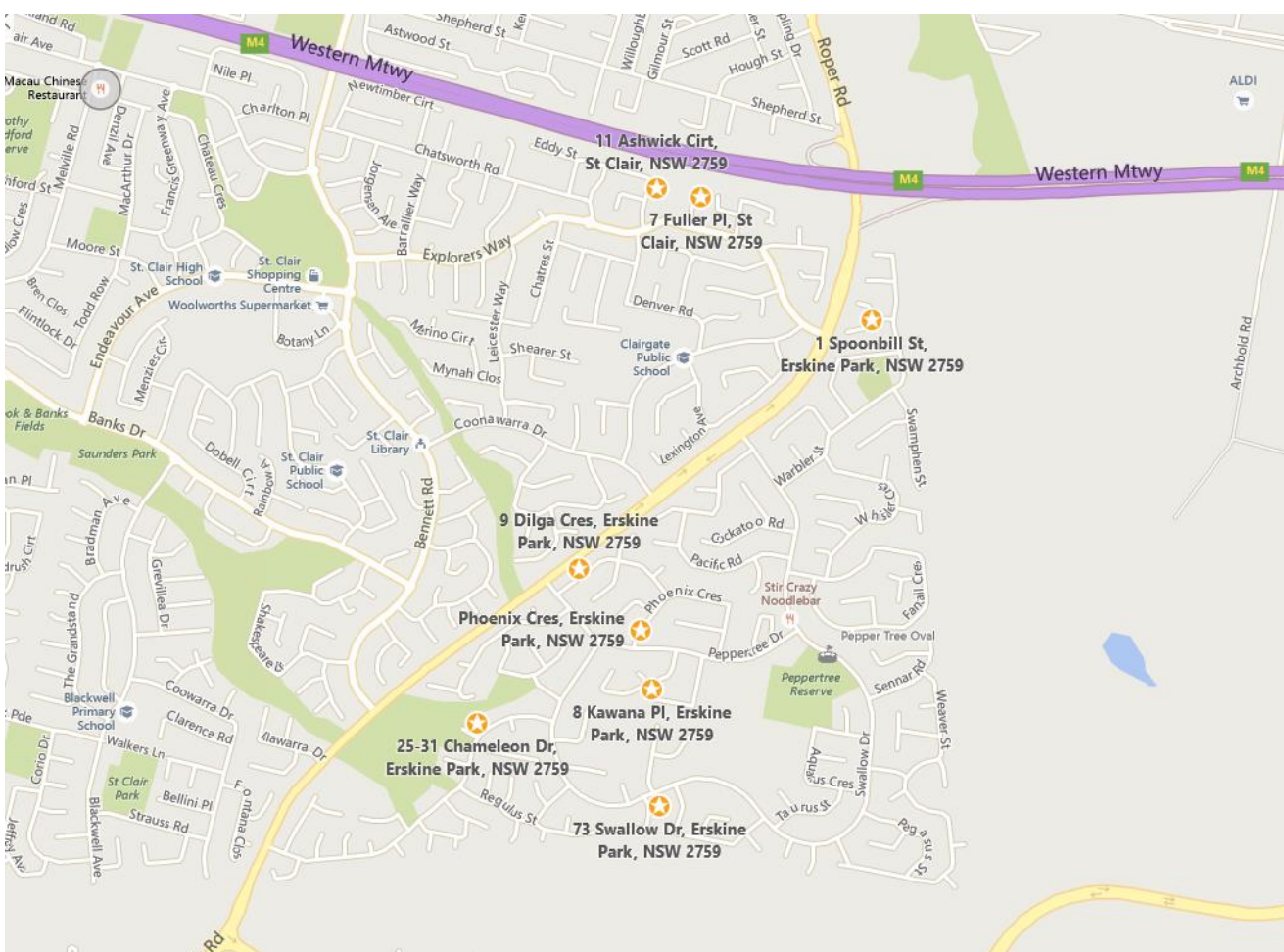

Figure 1 – Location of rezoning lots

1.2 Purpose of this Report

This report presents the following considerations in relation to the Traffic and Parking assessment to form part of a Planning Proposal to be prepared and submitted by Council.



- **Section 2** - A description of the project,
- **Section 3** - A description of the road network serving the development sites,

- **Section 4** - Determination of the traffic activity associated with the sub-division sites,
- **Section 5** - Assessment of car park provision,
- **Section 6** - Access assessment, and
- **Section 7** - Conclusion

2 The Proposal





We understand the Pilot Project in Erskine Park includes the potential rezoning and reclassification of 9 parcels of land¹. The subject of this traffic and parking assessment report involves 8 parcels of land within the suburbs of Erskine Park and St Clair, which Council are proposing to rezone and reclassify from public reserve to low density residential. Council is expecting this rezoning will yield 26 lots of which three (3) lots may have the potential for dual occupancy, resulting in up to 29 dwellings. The location of each of land parcel is identified in Figure 1, whilst Table 1 provided details of each of subdivision proposal.





Table 1 – Summary details of subdivision proposals (source: Penrith City Council, Oct 2015)

Site 1 - Spoonbill Reserve					
Address	Lot	Area for disposal	Current zone	Proposed zone	Subdivision Lot Yield
1a Spoonbill Street Erskine Park	Lot 104 DP706344	2,466 / 2,466 sqm	RE1 Public Recreation	R2 Low Density Residential	3 Lots
					
Site 2 - Regulus Reserve					
Address	Lot	Area for disposal	Current zone	Proposed zone	Subdivision Lot Yield
73 Swallow Drive Erskine Park	Lot 3280 DP786811	4,400 / 4,400 sqm	RE1 Public Recreation	R2 Low Density Residential	4 lots, plus 2 dual occupancy lots. This subdivision considers providing for 6 lots in total.
					

¹ Spica Reserve is not included in this assessment. Council is considering negotiating to sell the nominated dog leg section of this reserve to adjoining property owners for integration with their existing lots.

Site 3 - Dilga Crescent Reserve					
Address	Lot	Area for disposal	Current zone	Proposed zone	Subdivision Lot Yield
9A Dilga Crescent Erskine Park	Lot 148 DP703879	2,315 / 2,315 sqm	RE1 Public Recreation	R2 Low Density Residential	4 Lots
					
Site 4 - Pacific and Phoenix Reserve					
Address	Lot	Area for disposal	Current zone	Proposed zone	Subdivision Lot Yield
27A Phoenix Crescent, Erskine Park	Lot 1444 DP788282	1,234 / 12,510 sqm	RE1 Public Recreation	R2 Low Density Residential	2 Lots
					

Site 5 - Capella Street Reserve					
Address	Lot	Area for disposal	Current zone	Proposed zone	Subdivision Lot Yield
11A Canopus Place & 8a Kawana Place, Erskine Park	Lot 2174 DP776426 & Lot 376 DP713863	2,700 / 9,752 sqm	RE1 Public Recreation	R2 Low Density Residential	4 lots (accessed off Capella Street)
					
Site 6 - Part Chameleon Drive					
Address	Lot	Area for disposal	Current zone	Proposed zone	Subdivision Lot Yield
25 Chameleon Drive Erskine Park	Lot 1106 DP709078	2,484 / 2,484 sqm	RE1 Public Recreation	R2 Low Density Residential	4 lots
					

Site 7 - Ashwick Reserve					
Address	Lot	Area for disposal	Current zone	Proposed zone	Subdivision Lot Yield
11 Ashwick Circuit St Clair	Lot 35 DP812241	1,817 / 1,817 sqm	RE1 Public Recreation	R2 Low Density Residential	  <p>One lot could be considered as dual occupancy.</p>
Site 8 - Fuller Reserve					
Address	Lot	Area for disposal	Current zone	Proposed zone	Subdivision Lot Yield
6 Fuller Street St Clair	Lot 10 DP1001637	3,071 / 3,071 sqm	RE1 Public Recreation	R2 Low Density Residential	  <p>2 lots</p>

3 Existing Transport Facilities

Primary access to Erskine Park and St Clair is from Erskine Park Road, a state road which provides north-south access whilst the Western Motorway (M4) which intercepts Erskine Park Road to the north, provides primary east-west connectivity. These connections provide direct access to the Sydney CBD and Greater Western Sydney regions as presented in Figure 2.

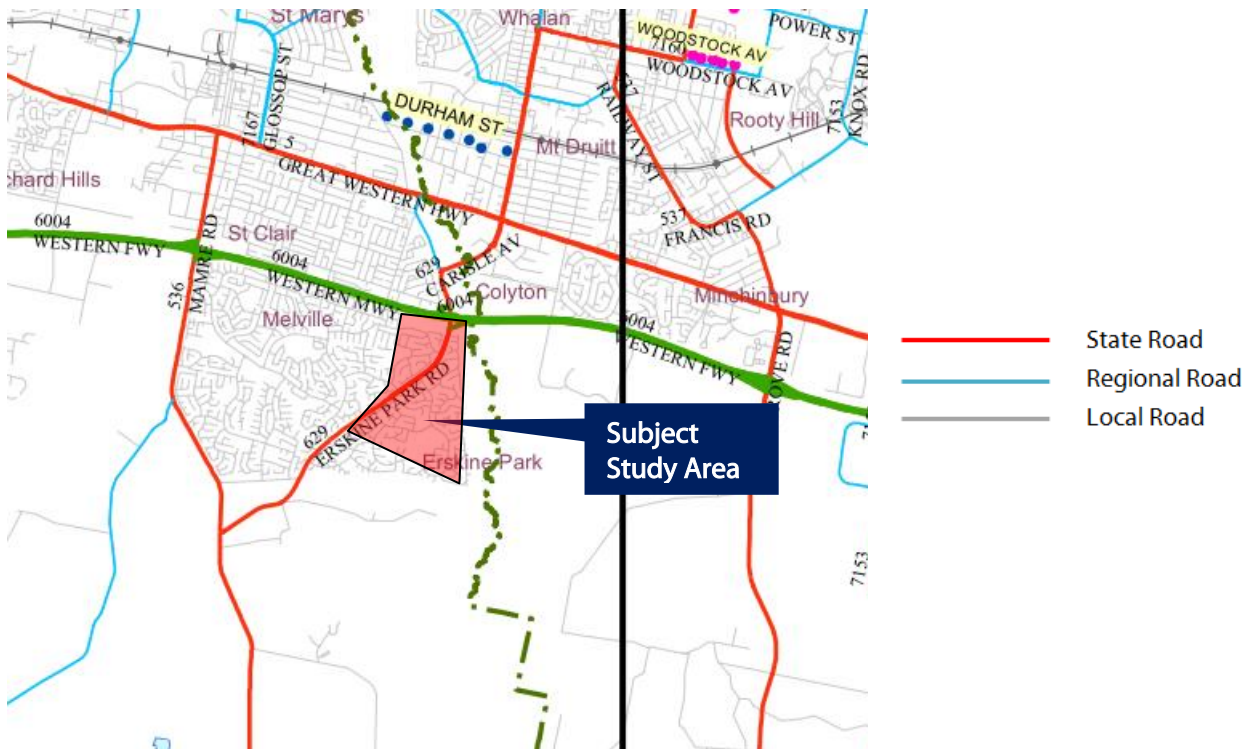

Figure 2 – Road Hierarchy (Source: RMS Road Hierarchy Review)

The NSW administrative road hierarchy comprises the following road classifications, which align with the generic road hierarchy as follows:

- **State Roads** - Freeways and Primary Arterials (RMS Managed)
- **Regional Roads** - Secondary or sub arterials (Council Managed, Part funded by the State)
- **Local Roads** - Collector and local access roads (Council Managed)

The roads servicing the sites are described in Tables below.

Table 2 – Existing Road Network - Western Motorway (M4)

Western Motorway (M4)	
Road Classification	State Road - Arterial
Alignment	East-West
Number of Lanes	3 lane each direction
Carriageway Type	Divided
Carriageway Width	54m (excluding 2.5m wide shoulders in each direction)
Speed Limit	110kph
School Zone	No

Parking Controls	No Stopping
Forms Site Frontage	No

Table 3 – Existing Road Network – Erskine Park Road

Erskine Park Road

Road Classification	State Road - Arterial
Alignment	North- South
Number of Lanes	2 lanes each direction of travel, reduces to 1 lane each direction passed Swallow Drive
Carriageway Type	Divided
Carriageway Width	20 m (excluding 2.5m wide shoulders in each direction)
Speed Limit	60kph northbound on approach to M4, 70kph southbound
School Zone	No
Parking Controls	No Stopping however sealed shoulders are provided on either side.
Forms Site Frontage	No

Table 4 – Existing Road Network – Explorers Way

Explorers Way

Road Classification	Local Road
Alignment	East-West
Number of Lanes	2
Carriageway Type	Undivided
Carriageway Width	13m
Speed Limit	50kph
School Zone	no
Parking Controls	Unrestricted parking permitted on both sides of roadway. Forms part of bus route circulating St Clair.
Forms Site Frontage	No

Table 5 – Existing Road Network – Spoonbill Street

Spoonbill Street

Road Classification	Local Street
Alignment	East-West
Number of Lanes	Two
Carriageway Type	Undivided
Carriageway Width	7.0m
Speed Limit	50kph
School Zone	No
Parking Controls	Parking permitted either side of roadway
Forms Site Frontage	Yes, primary frontage for property located at Spoonbill Reserve.

Table 6 – Existing Road Network – Swallow Drive

Swallow Drive

Road Classification	Local Street
Alignment	East-West
Number of Lanes	Two
Carriageway Type	Undivided
Carriageway Width	13m

Speed Limit	50kph
School Zone	no
Parking Controls	Unrestricted parking permitted on both sides of roadway. Bus stop located adjacent to property 73 Swallow Drive. Swallow Drive, forms part of bus route circulating within Erskine Park.
Forms Site Frontage	Yes, primary frontage for property located at Regulus Reserve

Table 7 – Existing Road Network – Dilga Crescent

Dilga Crescent	
Road Classification	Local Road
Alignment	North-South
Number of Lanes	Two
Carriageway Type	Undivided
Carriageway Width	7 m
Speed Limit	50kph
School Zone	No
Parking Controls	Unrestricted parking on both side of road.
Forms Site Frontage	Yes, primary frontage for property located at Dilga Reserve

Table 8 – Existing Road Network – Kawana Place

Kawana Place	
Road Classification	Local Road
Alignment	North-South
Number of Lanes	Two
Carriageway Type	Undivided
Carriageway Width	7 m
Speed Limit	50kph
School Zone	No
Parking Controls	Unrestricted parking on both side of road.
Forms Site Frontage	Yes, primary frontage for property located at Kawana Reserve

Table 9 – Existing Road Network – Phoenix Crescent

Phoenix Crescent	
Road Classification	Local Road
Alignment	North-South
Number of Lanes	Two
Carriageway Type	Undivided
Carriageway Width	7 m
Speed Limit	50kph
School Zone	No
Parking Controls	Unrestricted parking on both side of road.
Forms Site Frontage	Yes, primary frontage for property located at Pacific and Phoenix Reserve

Table 10 – Existing Road Network – Chameleon Drive

Chameleon Drive	
Road Classification	Local Road
Alignment	North-South
Number of Lanes	Two
Carriageway Type	Undivided
Carriageway Width	7 m
Speed Limit	50kph
School Zone	No
Parking Controls	Unrestricted parking on both side of road.
Forms Site Frontage	Yes, primary frontage for property Chameleon Reserve

Table 11 – Existing Road Network – Ashwick Circuit

Ashwick Circuit	
Road Classification	Local Road
Alignment	North-South
Number of Lanes	Two
Carriageway Type	Undivided
Carriageway Width	7 m
Speed Limit	50kph
School Zone	No
Parking Controls	Unrestricted parking on both side of road.
Forms Site Frontage	Yes, primary frontage for property located at Ashwick Reserve

Table 12 – Existing Road Network – Fuller Place

Fuller Place	
Road Classification	Local Road
Alignment	North-South
Number of Lanes	2 (unlinemarked)
Carriageway Type	Undivided
Carriageway Width	7 m
Speed Limit	50kph
School Zone	No
Parking Controls	Unrestricted parking on both side of road.
Forms Site Frontage	Yes, primary frontage for property located at Fuller Reserve

4 Development Traffic Assessment

4.1 Traffic Generation

The traffic generation of the proposed rezoning has been established with reference to the RMS Guide to Traffic Generating Developments, which presents the traffic generation rates for a number of land uses. The Guide was last updated in October 2002 and is largely based on surveys undertaken during the nineties.

RMS is currently updating the Guide to include more recent data and revised land use traffic generation rates, however as an interim measure RMS has recently published a Technical Direction titled TDT 2013/04a-Guide to Traffic Generating Developments-Updated Traffic Surveys, which provides preliminary updated traffic generation rates for a number of land-uses including residential development.

According to the Guide the proposed residential development is identified as a low density development and the updated the traffic surveys indicate the following traffic generation rates:

- Weekday average morning peak vehicle trips: 0.99 per dwelling (maximum 1.39)
- Weekday average evening peak vehicle trips: 0.95 per dwelling (maximum 1.32)

To present a robust assessment of the traffic activity associated with the proposal, we have adopted the maximum rate recommended by the RMS Technical Direction.

The proposal involves the subdivision of eight (8) properties to create 26-29² lots located throughout Erskine Park and St Clair. The projected traffic activity associated with the proposal has been calculated with reference to the maximum figures detailed above and the results are summarised in Table 13.

Table 13 – Traffic Generation

Site Location	Number of Lots	Weekday AM Peak (Maximum)		Weekday PM Peak (Maximum)	
		Rate (trips/dwelling)	Total Trips (veh/hour)	Rate (trips/dwelling)	Total Trips (veh/hour)
Swallow Drive					
1) 1A Spoonbill Street	3	1.39	4.2	1.32	4.0
TOTAL	3		4.2 (4) Trips		4.0 (4) Trips
Peppertree Drive					
2) 72 Swallow Drive	8	1.39	11.1	1.32	10.6
3) Dilga Crescent	4		5.6		5.3
4) 27A Phoenix Reserve	2		2.8		2.6
5) 8A Kawana Place	4		5.6		5.3
6) Chameleon Drive	4		5.6		5.3
TOTAL	22				30.7 (31) Trips
Explorer Way					
7) Ashwick Circuit	2	1.39	2.8	1.32	2.6
8) Fuller Place	2		2.8		2.6
TOTAL	4		5.6 (6) Trips		5.2 (5) Trips

² At 72 Swallow Drive the development proposes 2 lots as dual occupancy, this result in an additional 2 dwellings, whilst Ashwick Circuit proposes an option for the lot as a dual occupancy, for this purpose of this assessment; a dual occupancy has been adopted.

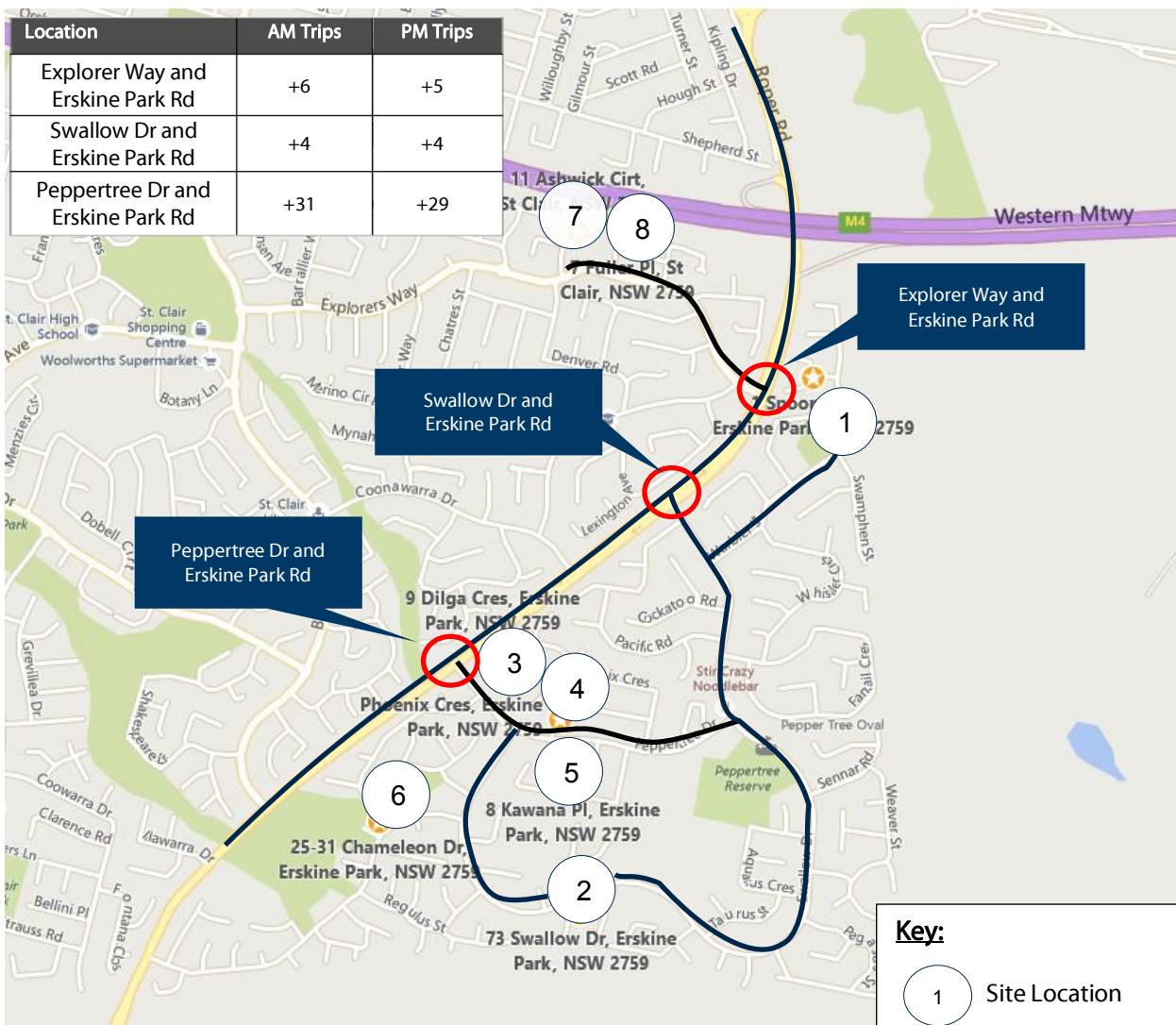

Figure 3 –Distribution of Traffic on Erskine Park Road

It is acknowledged that the proposal is likely to lead to increased traffic volumes along Erskine Park Road at three different intersections. The greatest increase in movements occurs at the intersection of Peppertree Drive and Erskine Park Road being up to 31 trips. This equates to a trip every 1.9 minutes, which is unlikely to have any significant impact on the adjacent road network.

In addition to this the following additional considerations are made:

- The access and egress movements distributed to the intersection of Peppertree Drive and Erskine Park Road, could also access Erskine Park Road at the intersection with Swallow Drive. Swallow Drive at Erskine Park Road is a signalised junction, which provides dedicated green phase time for vehicles turning out of Swallow Drive to travel north on Erskine Park Road. Therefore this route provides a more controlled access to Erskine Park Road and may result in this intersection being the preferential access for vehicles wanting to travel north.
- Traffic egressing from the lots located close to Peppertree Drive can safely do so at breaks in through-traffic created by the nearby signalised intersection Swallow Drive.

The assessment of traffic activity has established that the proposed subdivision will have no notable impact upon the operation of the surrounding road network. Accordingly, the intersections within the vicinity of the site will continue to operate similarly to the existing operation and therefore, will not require any upgrades.

5 Car Parking Provision

5.1 Planning Policy Requirements

Typically, parking requirements are established with reference to the local planning controls i.e. Development Control Plan (DCP) and Local Environmental Plan (LEP). Penrith City Council has developed the C10 Transport Access and Parking DCP prepared in 2014, which stipulates car parking rates for various developments. A reproduction of the rates applicable to this rezoning application is presented in the table below.

Table 14 – Parking Requirements

Type of Development	Car Parking Spaces per dwelling
Dwelling House	2 spaces per dwelling – stack or tandem parking is acceptable
Dual Occupancy	2 spaces per dwelling – stack or tandem parking is acceptable

Additionally, Section 5 of the RMS Guide to Traffic Generating Developments also presents the following parking requirement for residential development.

A minimum of one (1) parking space (preferably two (2)) is recommended for dwelling houses.

The Guide also indicates that the parking requirements for dwelling houses can vary substantially between local government areas, due to varying levels of public transport accessibility as well as geographic and social-economic factors.

5.2 Car Parking Requirements

At this stage no plan has been developed to indicate the parking provision. However, during the later stages of the project, a detailed parking assessment statement of the parking provision including compliance with the relevant applicable standards i.e. AS2890.1 (2004) will be submitted to Council. As a minimum, the design of car parking shall be based on a User Class 1A facility associated with a residential, domestic and employee parking. Regarding this class, AS2890.1 requires the following minimum specifications:

- Spaces: 2.4m x 5.4m; and
- Aisle Width: 5.8m

6 Access Assessment

6.1 Vehicular Access

The rezoning of eight (8) properties within Erskine Park and St Clair will involve the use of the existing internal road network. This application does not result in or propose any changes to the road geometry or access arrangements.

To satisfy the general requirements in Section 10.5.2 Access and Driveways of the DCP, vehicular access for each domestic property fronting a local road shall be designed in accordance with AS2890.1:2004 Parking Facilities Part 1: Off-Street car parking. As a minimum, the following must be considered as part of the design:

- The maximum grade for a domestic driveway shall be 1 in 4 (25%). Where the access driveway crosses a footpath into the property the maximum grade of 1 in 20 (5%).
- The driveway location for an access driveway Category 1 shall not be located in the sections of kerb shown as heavy lines in Figure 3.1 of AS 2890.1:2004. This requirement does not apply for domestic driveways, in a kerb section opposite the entering road at any intersection including signalised intersections. Unless otherwise denied access due to the physical impossibility of meeting these requirements.

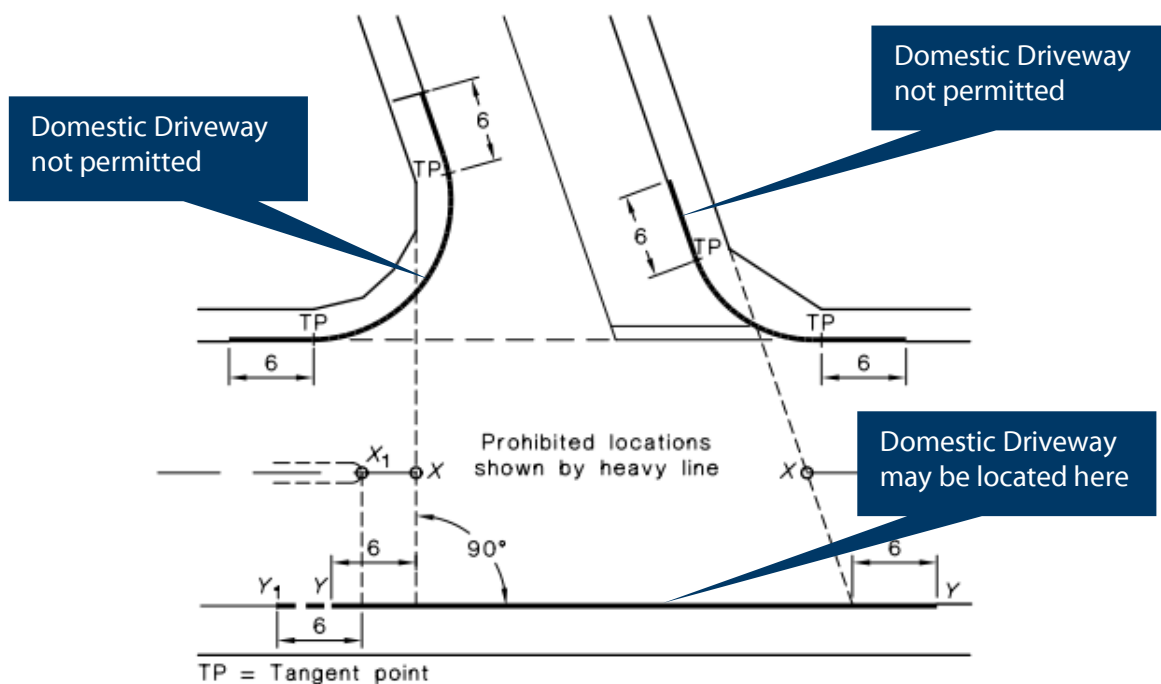

NOTES:

- 1 Accesses to domestic driveways are excluded from the prohibition in respect of the kerb section marked Y-Y (see Clause 3.2.3(a)).
- 2 The points marked X_1 and X are respectively at the median end on a divided road and at the intersection of the main road centre-line and the extensions of the side road property lines shown as dotted lines, on an undivided road. On a divided road, dimension Y-Y extends to Point Y_1 .

DIMENSIONS IN METRES

FIGURE 3.1 PROHIBITED LOCATIONS OF ACCESS DRIVEWAYS

6.2 Sight Distances

The following section reviews the sight distance requirements for each proposed property. The sight distance requirements are determined with reference to Section 3.2 of the Australian Standard for Off Street Parking Facilities - AS2890.1, and are based on the posted speed limit or 85th percentile vehicle speeds. In assessing all roads, it is noted they are classified as local roads and have a posted speed limit of 50kph. Within AS2890.1 it specifies that for frontage roads with a speed limit of 50kph a minimum sight distance of 40 metres is required.

The design should consider sight distance for entering the roadway, as well as minimum sight lines for pedestrian safety. An extract of the minimum sight distance for entering traffic into the roadway and pedestrian safety is provided below.

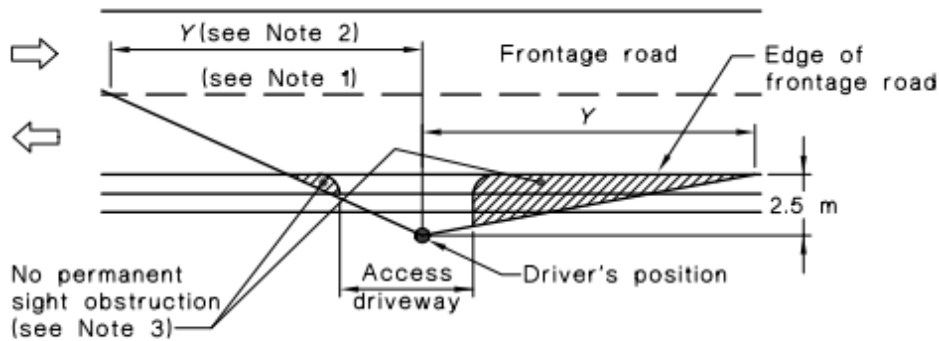

Frontage road speed (Note 4) km/h	Distance (Y) along frontage road m		
	Access driveways other than domestic (Note 5)		Domestic property access (Note 6)
	Desirable 5 s gap	Minimum SSD	
40	55	35	30
50	69	45	40
60	83	65	55
70	97	85	70
80	111	105	95
90	125	130	Use values from 2 nd and 3 rd columns
100	139	160	
110	153	190	

NOTES:

- 1 Centre-line or centre of road (undivided road), or right hand edge of right hand through lane (divided road).
- 2 A check to the left is not required at a divided road where the median is wide enough to shelter a vehicle leaving the driveway.
- 3 Parking on this side of the frontage road may need to be restricted on either side of the driveway so that the sight distance required by the above table to an approaching vehicle is not obstructed.
- 4 This is the posted or general speed limit unless the 85th percentile speed is more than 5 km/h above the limit in which case the tabulated speed nearest the 85th percentile shall be adopted.
- 5 The values in the table apply only to left turn and right turn manoeuvres into two-way roads up to four lanes wide and one-way streets regardless of width, either for a 5 s gap, desirable at lower frontage road speeds, or minimum stopping sight distance based on 2 s reaction time.
Crossing manoeuvres (e.g. from an access opposite the stem of a T-junction) over four lanes or more, and turning manoeuvres into a six lane two-way road would require longer gaps unless there was a median wide enough to store a vehicle and allow a two stage manoeuvre.
- 6 These distances are based on stopping sight distances with reaction time of 1.5 s for traffic approaching along the frontage road and are applicable to a frontage road speed of up to 80 km/h only. Wherever practicable sight distance provided at domestic property accesses should meet the values given in the second or third columns of the Table.
- 7 When checking sight distance the driver's eye height and the height of the object (approaching vehicle) are to be taken as 1.15 m above the road surface.

FIGURE 3.2 SIGHT DISTANCE REQUIREMENTS AT ACCESS DRIVEWAYS

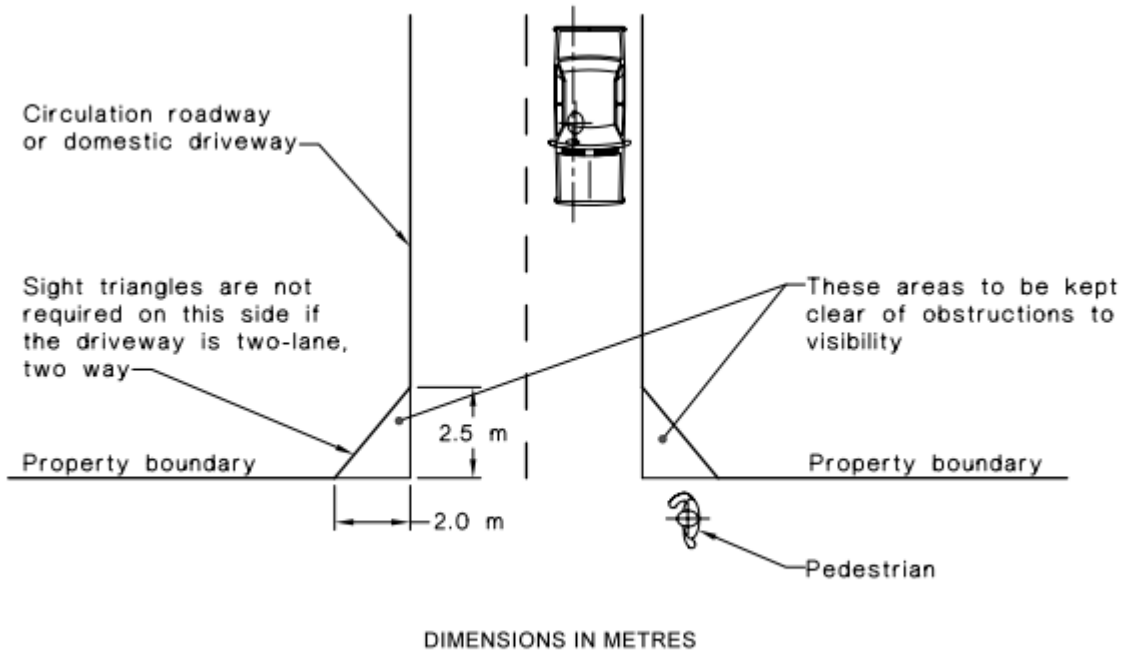





FIGURE 3.3 MINIMUM SIGHT LINES FOR PEDESTRIAN SAFETY

In reviewing the above vehicular access and sight distance design considerations the following table overleaf provides a general overview of compliance considerations associated with each property.

Site	Aerial	Design	Compliance considerations
<p>Spoonbill Reserve</p> <p>1a Spoonbill Street Erskine Park</p>			<p>The site is positioned on fairly flat terrain. The 40m visibility extents towards the intersection located to the east of the site resulting in good visibility upstream and downstream of the driveways.</p> <p>The position of all vehicular accesses is sufficiently spaced 6m away from the kerb corner of an intersection.</p> <p>Design to consider minimising vegetation and parking west of the subdivision site to ensure vehicles are able to access the driveways.</p>

Site	Aerial	Design	Compliance considerations
<p>Regulus Reserve</p> <p>73 Swallow Drive, Erskine Park</p>			<p>Site grade is steep from Swallow Drive to the near of the property. Consideration is required in design to assess sight distance of driveway located on a grade considering the retention of the existing bus stop. Design also needs to consider the sight lines required for pedestrian safety using the footpath along Swallow Drive.</p> <p>The position of all vehicular accesses is sufficiently spaced 6m away from the kerb corner of an intersection.</p> <p>Design to consider minimising vegetation and parking west of the subdivision site to ensure vehicles are able to access the driveways.</p>

Site	Aerial	Design	Compliance considerations
<p>Dilga Reserve</p> <p>1a Dilga Reserve</p>			<p>No access to Erskine Park Road permitted.</p> <p>The position of all vehicular accesses is sufficiently spaced 6m away from the kerb corner of an intersection.</p> <p>Design to consider minimising vegetation and parking west of the subdivision site to ensure vehicles are able to access the driveways.</p>
<p>11a Canopus Place</p>			<p>The site is positioned on fairly flat terrain.</p> <p>Access into Lots 4, 5 and 6 considers a battle-axe allotment design. The minimum battle axe width is 10m required under the DCP.</p> <p>The position of all vehicular accesses is sufficiently spaced 6m away from the kerb corner of an intersection.</p> <p>Design to consider minimising</p>

Site	Aerial	Design	Compliance considerations
			<p>vegetation and parking west of the subdivision site to ensure vehicles are able to access the driveways.</p>
<p>27A Phoenix Reserve</p>			<p>The site is positioned on fairly flat terrain.</p> <p>The position of all vehicular accesses is sufficiently spaced 6m away from the kerb corner of an intersection.</p> <p>Design to consider minimising vegetation and parking west of the subdivision site to ensure vehicles are able to access the driveways.</p>

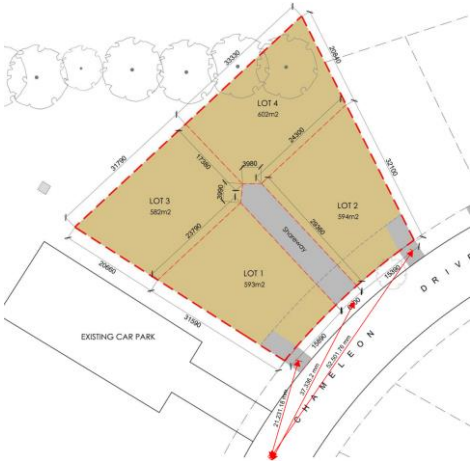
Site	Aerial	Design	Compliance considerations
<p>25 Chameleon Drive</p>			<p>The site is positioned on fairly flat terrain.</p> <p>Access into lots 3 and 4 is considered as a battle-axe design. The minimum battle axe width is 10m required under the DCP.</p> <p>The position of all vehicular accesses is sufficiently spaced 6m away from the kerb corner of an intersection.</p> <p>Design to consider minimising vegetation and parking west of the subdivision site to ensure vehicles are able to access the driveways.</p>

Site	Aerial	Design	Compliance considerations
<p>11 Ashwick Circuit</p>			<p>The site is positioned on fairly flat terrain.</p> <p>The position of all vehicular accesses is sufficiently spaced 6m away from the kerb corner of an intersection.</p> <p>Design to consider minimising vegetation and parking west of the subdivision site to ensure vehicles are able to access the driveways.</p>

Site	Aerial	Design	Compliance considerations
6 Fuller Place			<p>The position of the access Lots 1 and 2 may be widened to take into consideration its location in a cul-de-sac.</p> <p>Design to consider minimising vegetation and parking adjacent to subdivision site to ensure vehicles are able to access the driveways.</p>

7 Conclusion

In summary, this report presents an assessment of the traffic and parking implications associated with a proposal to rezone and subdivide eight (8) individual properties to provide up to 26 lots. The proposal involves no changes to the existing internal road network.

The assessment of traffic activity has established that the proposed subdivision will have no notable impact upon the operation of the surrounding road network. According the intersections within the vicinity of the site will continue to operate similarly to the existing operation and therefore, will not require any upgrades.

In this regard, the proposal in relation to the traffic and parking assessment will have no notable impact upon the operation of overall road network.